



Operator's Manual Supplement

Traveling Fall Arrest Anchor System

Original Instructions

First Edition

Fifth Printing

Part No. 1256390GT

Introduction

Genie Self-propelled Boom Products and Fall Arrest Guidance

Background

Booms are designed to carry personnel to elevated work locations. A personal fall protection system in addition to the platform guard rails is required by OSHA in the United States and other regulatory agencies in many parts of the world. Personal fall protection can consist of a fall restraint and/or fall arrest system. Depending on the work being performed either a fall restraint system or a fall arrest system should be selected while in the platform. Sometimes work must be performed by stepping out of the basket onto an adjacent structure. If the adjacent structure is not equipped to provide appropriate fall protection, the Genie boom may be used as a fall arrest anchor.

This document provides guidance for the use of Genie Booms to serve as fall arrest anchorages.

Definitions

Qualified person

A "qualified person" one who, by possession of a recognized degree, certificate, or professional standing, or by extensive knowledge, training and experience, has demonstrated his/her ability to solve or resolve problems related to the subject matter, the work, or the project.

Fall Restraint Systems

Restraint systems prevent a worker from being exposed to a fall. If the employee is protected by a restraint system, either a body belt or a harness may be used. When a restraint system is used for fall protection in a boom supported aerial work platform, the employer/user/operator must ensure that the lanyard and anchor are arranged so that the operator is not exposed to falling any distance outside the platform.

Fall Arrest Systems

A system that permits an arrested fall is considered a fall arrest system. A body belt is prohibited in a fall arrest system and instead a full body harness and lanyard that limits the fall distance and arresting force on the person is required. Fall arresting lanyards typically have a shock absorbing section or are a self-retracting lifeline/lanyard.

Self-retracting lifeline/lanyard

A deceleration device containing a drum-wound line which can be slowly extracted from, or retracted onto, the drum under slight tension during normal employee movement, and which after onset of a fall, automatically locks the drum and arrests the fall. The use of the self-retracting lifeline/lanyard as a fall arrest lanyard is allowed on boom-supported aerial work platforms. If a self-retracting lifeline/lanyard is used while exiting the platform it shall not allow a free fall greater than six feet.

Introduction

Personal Fall Protection Preference

When designing a work space/condition the order of preference for fall protection is:

- 1 Fall restraint - Prevent the occurrence of a fall
- 2 Fall arrest - Reduce injuries occurring during the fall

Genie Self-propelled Booms may be used as a fall arrest anchor including working outside of the platform under the following guidelines:

- 1 The owner/employer/user/operator of the boom is responsible for providing fall protection for boom operators.
- 2 A "qualified person" with knowledge of fall protection regulations and systems must design the work space and the fall arrest system to insure worker safety.
- 3 Genie Booms have been stability tested on level ground for a 300 lb / 136 kg person experiencing fall arrest with the remaining rated load in the platform. Therefore the weight of the worker, including tools and equipment, exiting the platform while attached to one of the platform's lanyard anchorages must not exceed 300 lbs / 136 kg.
- 4 The maximum arresting force must not exceed 900 lbs / 4.0 kN.
- 5 The fall arrest system must not allow a potential free fall greater than 6 ft / 1.8 m.
- 6 Only one person may exit or work outside the platform while attached to an approved lanyard attachment point.
- 7 The weight of a person working outside the platform while attached to an approved lanyard attachment point must be included in the platform load calculation.
- 8 Employers and operators must be aware of and plan for potential vertical and horizontal platform movement while exiting or entering an elevated boom platform.
- 9 The boom must be on firm level ground to be considered usable as a fall arrest anchorage.
- 10 A person trained in the operation of the Genie boom shall remain on the ground near the machine base controls to prevent unauthorized use and to prevent the machine from being operated while used as a fall arrest anchor.
- 11 The fall protection system must comply with all applicable local, provincial, federal, job site, and manufacturer's requirements for the use of personal fall protection equipment.
- 12 Do not operate the boom once the operator has tied off and exited the platform.

Introduction

- 13 When designing fall arrest systems the following should be taken into account:
- Lanyard free fall distance
 - Maximum allowable deceleration distance
 - Maximum lock-up length (for the self retracting lifeline/lanyard only)
 - Any stretch in the lifeline or lanyard outside of the deceleration distance.
 - The height of the operator
 - Any harness effects including self retracting lanyards
 - Safety factor (a suitable amount to ensure that the required clearance between the operator and the lower surface is met)
 - Any movement of the platform due to dynamic loading
 - Any obstructions under the platform
 - Any other traffic or distractions that could affect safety

Owner/Employer/User/Operator Requirements:

- 1 Operators must be trained and qualified on safe operation of the equipment, and be familiar with the specific model of Genie equipment as follows:
 - Be familiar and comply with the equipment operating and safety manuals, decals and warnings.
 - Understand all control functions.
 - Be aware of and understand all safety devices specific to the equipment being used.
 - Be instructed how to avoid the hazards.
- 1 Comply with all applicable jobsite, local, state, provincial, and federal rules and regulations, and standards related to the use of the equipment.
- 2 The equipment must be in proper working condition and configuration.

In consideration for Genie's guidance herein, the equipment owner, employer, user and operator hereby agree to indemnify and hold harmless Terex USA and its parent and affiliated companies against any and all liabilities, claims, suits, losses, costs and legal fees caused by, arising out of, or resulting from any negligent act or omission in the operation of the equipment; the failure to comply with the criteria set forth in this letter related to the use of a boom as a Fall Arrest anchorage; the safety rules and operating instructions in the Operator's Manual. **By proceeding with the use of a boom as a Fall Arrest anchorage, you agree to adhere to the requirements set forth herein, including said indemnification. If you do not agree, do not proceed with the proposed use.**

Introduction



Danger

Failure to obey the instructions and safety rules in this manual and in the operator's manual for this machine will result in death or serious injury.

Note

The Traveling Fall Arrest Anchor System (TFAAS) is only authorized for use in the ANSI, CSA and CE markets. All other markets are prohibited from use.

The TFAAS can only be used on Genie Booms equipped with the following 6 ft / 1.83 m / 8 ft / 2.44 m platforms:

- ▲ Standard entry platforms manufactured from January, 2003

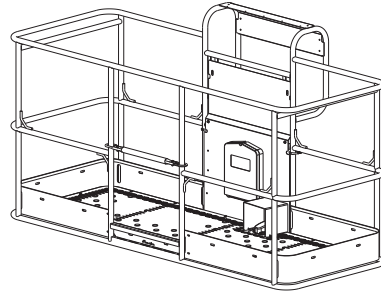

- ▲ Side entry swing gate platforms manufactured from August, 2015

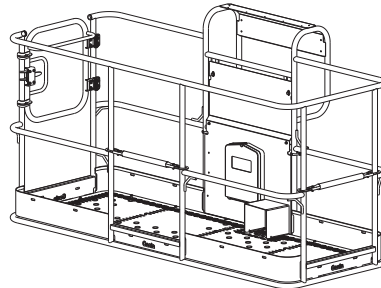

Use on all other machines is prohibited.

Introduction

The TFAAS can not be used with machines equipped with the following:

- ▲ Panel cradle option
- ▲ Center mounted swing gate option

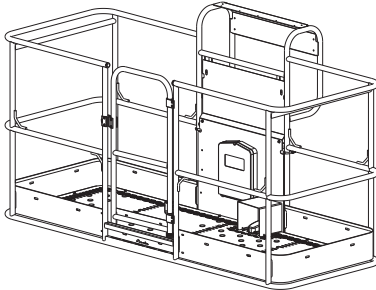

- ▲ Tri-entry platform with three sliding mid-rails

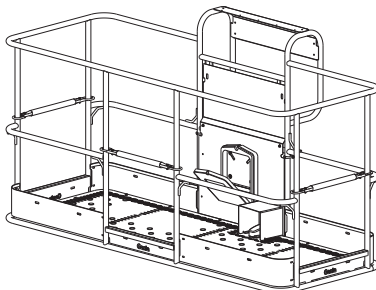

- ▲ Tri-entry platform with two sliding mid-rails and center mounted swing gate

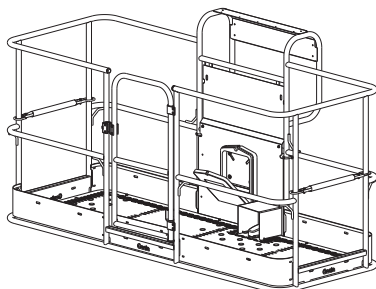

▲ DANGER Using the TFAAS with the above options could result in death or serious injury.

▲ TFAAS Safety

Read, understand and obey all warnings and instructions provided with the TFAAS.

Do not exceed the rated platform capacity. The weight of the TFAAS assembly will reduce the rated platform capacity and must be subtracted from the total platform load.

The TFAAS assembly weighs 50 lbs / 23 kg.

Be sure the TFAAS is securely installed.

When the TFAAS structure is attached, this manual should be considered a permanent part of your machine and should remain with the machine at all times.

Introduction

Symbol and Hazard Pictorials Definitions



TFAAS weighs
50 lbs / 23 kg



Read the supplement,
part number 1256390.



Tip over hazard.

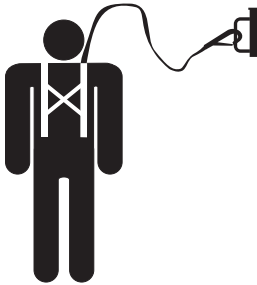

Maximum capacity
300 lbs / 136 kg.

Pre-operation Inspection

- Be sure that the operator's manual, safety manual, responsibilities manual and any necessary supplements are complete, legible and in the storage container located in the platform.
- Be sure that all decals are legible and in place.

Check the TFAAS for damage or wear, improperly installed, loose or missing parts and unauthorized modifications.

- Nuts, bolts and other fasteners
- Cracks in welds or structural components
- Dents or damage to TFAAS
- Verify that the lanyard attachment trolley can move freely along the entire length of the track

Decal Inspection

Use the inspection to verify that all decals are legible and in place. Decals may vary depending on machine configuration.

Part No.	Decal Description	Qty
40434	Decal, Lanyard attachment	1
1256400	Decal, TFAAS Track, Word	1
1256400FR		
1260910	Decal, TFAAS Track, Symbol	1

Introduction

Annual Inspection

Inspect for missing or loose components.

Check all fasteners for proper torque. Refer to the installation instructions section of this document for the torque specifications.

Inspect all components for damage or wear. Check for cracks, bends and corrosion.

Inspect all welds for cracks.

Inspect the lower track flanges. If the flanges are bent, damaged or worn, replace the track.

Verify the lanyard attachment trolley can freely move the entire length of the track.

Test the operation of the lanyard attachment eye on the trolley and verify that it can rotate freely.

Test the operation of the lanyard attachment trolley and verify the wheels rotate freely.

Verify the track end stops and hardware are present and secure.

Inspection After a Fall

Note: In the event of an operator fall, the TFAAS and the Genie boom must be immediately removed from service and inspected by a "qualified person". If the TFAAS and the Genie boom pass the inspections listed below, the TFAAS and the Genie boom may be returned to service.

Inspect all structural components of the TFAAS and the Genie boom. Replace any bent or damaged components. Replace any components with cracked welds. Replace all mounting fasteners for the TFAAS.

Perform an Annual Inspection on the TFAAS

Perform a Pre-Operation Inspection on both the TFAAS and the Genie boom.

Installation Instructions



Observe and Obey:

- This procedure shall be completed by a person authorized to install the TFAAS.
- Immediately tag and remove from service a damaged or malfunctioning machine.
- Repair any machine damage or malfunction before operating the machine.

Before Starting Installation

- Read, understand and obey the safety rules and operating instructions in the appropriate Genie Operator's Manual and Supplements.
- Be sure that all necessary tools and parts are available and ready for use.
- Read this procedure completely and adhere to the instructions. Attempting shortcuts may produce hazardous conditions.

Notes:

- New mounting hardware must be used with each new installation of the TFAAS, including re-installation on the same machine. A replacement hardware kit (Genie part number 1260849) is available through the Genie Parts Department.
- Refer to the illustration page for installation instructions.

Contents of Kit 1256377

For use with 8 ft / 2.44 m platforms with word decals.

Part Description	Genie Part Number	Qty.
(1) Track assembly, 8 ft / 2.44 m	*1256379	1
(2) Spacer	1256481	8
(3) Inner hanger	1256389	2
(4) Screw, 3/8-16 x 2.5 **	1256856	8
(5) Flange nut, 3/8-16 **	1274322	8
(6) Manual, Supplement	1256390	1

Components of *1256379

Part Description	Genie Part Number	Qty.
(7) Trolley	1256439	1
(8) Decal, Lanyard attachment	40434	1
(9) Decal, TFAAS track, Word	1256400	1
(10) Screw, 1/2-13 x 3.5 ***	1256851	2
(11) Flange nut, 1/2-13 ***	1251997	2
(12) Rubber bumper	36388	2
(13) End stop	1260892	2
(14) Weldment, 8 ft / 2.44 m track	1256381	1

** Torque to 44 ft-lbs / 60 Nm

*** Tighten until snug. Do not over tighten or the track may be damaged.

Installation Instructions

Contents of Kit 1256378

For use with 6 ft / 1.83 m platforms with word decals.

Part Description	Genie Part Number	Qty.
(1) Track assembly, 6 ft / 1.83 m	*1256380	1
(2) Spacer	1256481	8
(3) Inner hanger	1256389	2
(4) Screw, 3/8-16 x 2.5 **	1256856	8
(5) Flange nut, 3/8-16 **	1274322	8
(6) Manual, Supplement	1256390	1

Components of *1256380

Part Description	Genie Part Number	Qty.
(7) Trolley	1256439	1
(8) Decal, Lanyard attachment	40434	1
(9) Decal, TFAAS track, Word	1256400	1
(10) Screw, 1/2-13 x 3.5 ***	1256851	2
(11) Flange nut, 1/2-13 ***	1251997	2
(12) Rubber bumper	36388	2
(13) End stop	1260892	2
(14) Weldment, 6 ft / 1.83 m track	1256383	1

Contents of Kit 1261018

For use with 8 ft / 2.44 m platforms with French Decals.

Part Description	Genie Part Number	Qty.
(1) Track assembly, 8 ft / 2.44 m	*1261020	1
(2) Spacer	1256481	8
(3) Inner hanger	1256389	2
(4) Screw, 3/8-16 x 2.5 **	1256856	8
(5) Flange nut, 3/8-16 **	1274322	8
(6) Manual, Supplement	1256390FR	1

Components of *1261020

Part Description	Genie Part Number	Qty.
(7) Trolley	1256439	1
(8) Decal, Lanyard attachment	40434	1
(9) Decal, TFAAS track, French	1256400FR	1
(10) Screw, 1/2-13 x 3.5 ***	1256851	2
(11) Flange nut, 1/2-13 ***	1251997	2
(12) Rubber bumper	36388	2
(13) End stop	1260892	2
(14) Weldment, 8 ft / 2.44 m track	1256381	1

** Torque to 44 ft-lbs / 60 Nm

*** Tighten until snug. Do not over tighten or the track may be damaged.

Installation Instructions

Contents of Kit 1261019

For use with 6 ft / 1.83 m platforms with French Decals.

Part Description	Genie Part Number	Qty.
(1) Track assembly, 6 ft / 1.83 m	*1261021	1
(2) Spacer	1256481	8
(3) Inner hanger	1256389	2
(4) Screw, 3/8-16 x 2.5 **	1256856	8
(5) Flange nut, 3/8-16 **	1274322	8
(6) Manual, Supplement	1256390FR	1

Components of *1261021

Part Description	Genie Part Number	Qty.
(7) Trolley	1256439	1
(8) Decal, Lanyard attachment	40434	1
(9) Decal, TFAAS track, French	1256400FR	1
(10) Screw, 1/2-13 x 3.5 ***	1256851	2
(11) Flange nut, 1/2-13 ***	1251997	2
(12) Rubber bumper	36388	2
(13) End stop	1260892	2
(14) Weldment, 6 ft / 1.83 m track	1256383	1

Contents of Kit 1261022

For use with 8 ft / 2.44 m platforms with symbol Decals.

Part Description	Genie Part Number	Qty.
(1) Track assembly, 8 ft / 2.44 m	*1261024	1
(2) Spacer	1256481	8
(3) Inner hanger	1256389	2
(4) Screw, 3/8-16 x 2.5 **	1256856	8
(5) Flange nut, 3/8-16 **	1274322	8
(6) Manual, Supplement	1256390	1

Components of *1261024

Part Description	Genie Part Number	Qty.
(7) Trolley	1256439	1
(8) Decal, Lanyard attachment	40434	1
(9) Decal, TFAAS track, Symbol	1260910	1
(10) Screw, 1/2-13 x 3.5 ***	1256851	2
(11) Flange nut, 1/2-13 ***	1251997	2
(12) Rubber bumper	36388	2
(13) End stop	1260892	2
(14) Weldment, 8 ft / 2.44 m track	1256381	1

** Torque to 44 ft-lbs / 60 Nm

*** Tighten until snug. Do not over tighten or the track may be damaged.

Installation Instructions

Contents of Kit 1261023

For use with 6 ft / 1.83 m platforms with symbol Decals.

Part Description	Genie Part Number	Qty.
(1) Track assembly, 6 ft / 1.83 m	*1261025	1
(2) Spacer	1256481	8
(3) Inner hanger	1256389	2
(4) Screw, 3/8-16 x 2.5 **	1256856	8
(5) Flange nut, 3/8-16 **	1274322	8
(6) Manual, Supplement	1256390	1

Components of *1261025

Part Description	Genie Part Number	Qty.
(7) Trolley	1256439	1
(8) Decal, Lanyard attachment	40434	1
(9) Decal, TFAAS track, Symbol	1260910	1
(10) Screw, 1/2-13 x 3.5 ***	1256851	2
(11) Flange nut, 1/2-13 ***	1251997	2
(12) Rubber bumper	36388	2
(13) End stop	1260892	2
(14) Weldment, 6 ft / 1.83 m track	1256383	1

** Torque to 44 ft-lbs / 60 Nm

*** Tighten until snug. Do not over tighten or the track may be damaged.

Installation Instructions

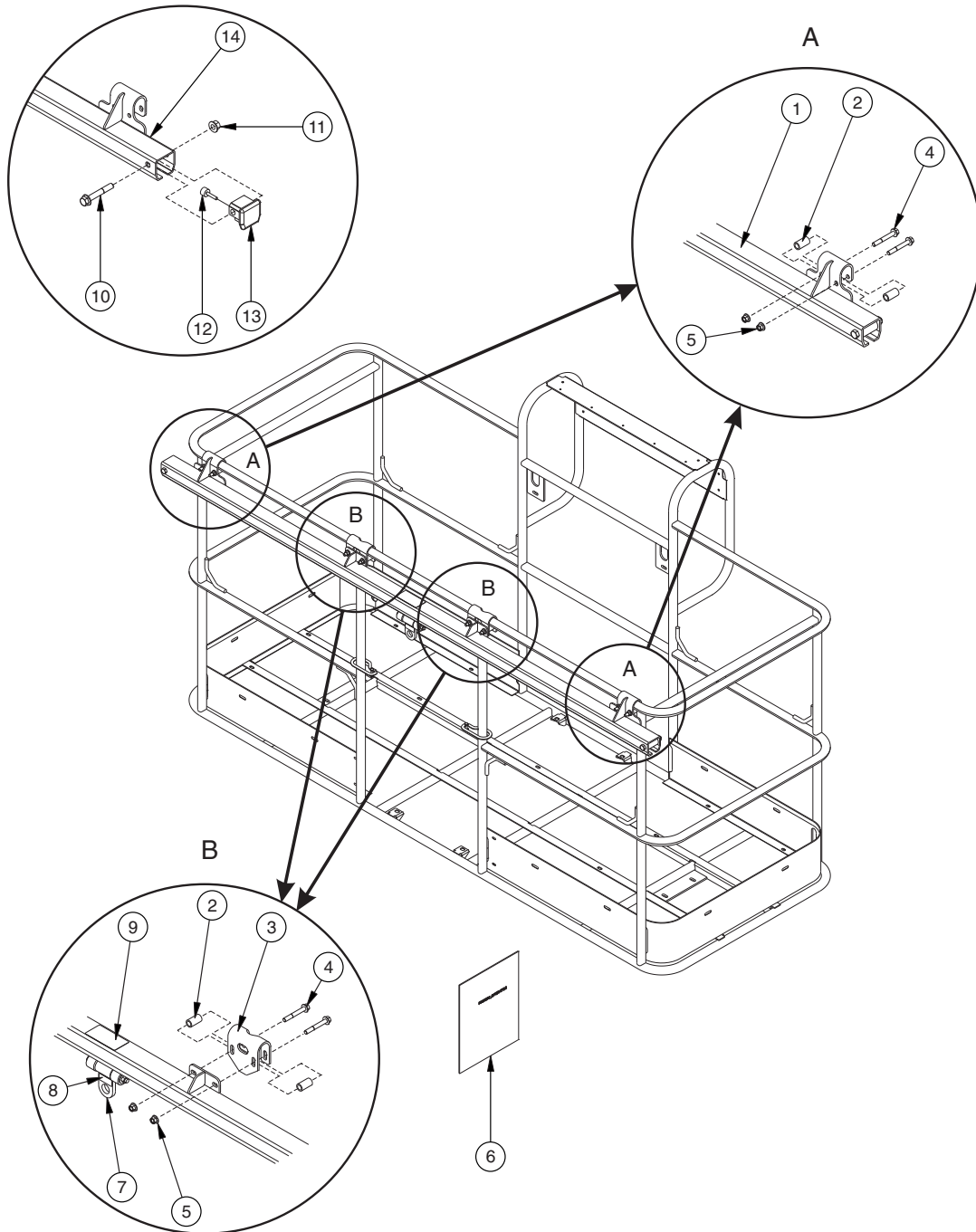

www.genielift.com

Distributed By: